

## Self Aligning Foot

- Low profile self aligning foot
- Designed for use with the 3410/3510 T end load cells.
- Neoprene rubber and stainless steel construction
- Available for capacities from 250 Kg to 5000 Kg
- Especially designed for platform scales
- Very easy to install

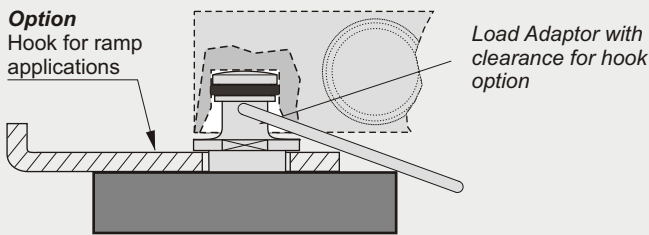
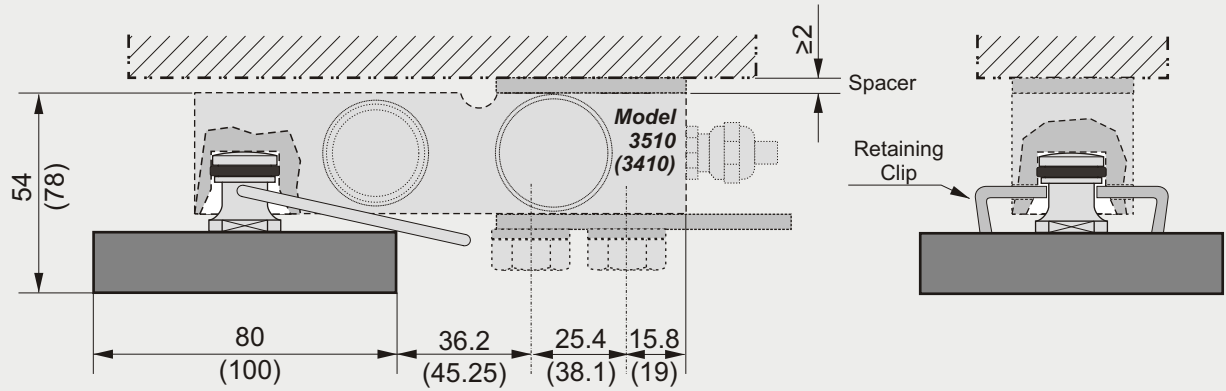

**The Self Aligning Foot consists of :**

1. A rubber & metal disc with an M12 thread (250 - 2000 kg)
  - Neoprene rubber with a Shore Hardness 55 - 65
  - A Stainless Steel plate, 6mm thick
2. A stainless steel load adaptor  
Material 1.4112, hardened to 54 - 56 RC
3. Retaining clip

**Note !**

All dimensions in brackets ( ) are for the 5T version only.

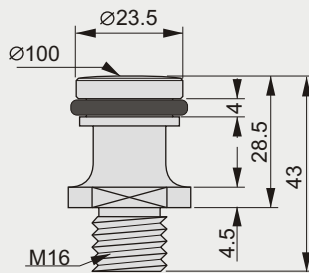
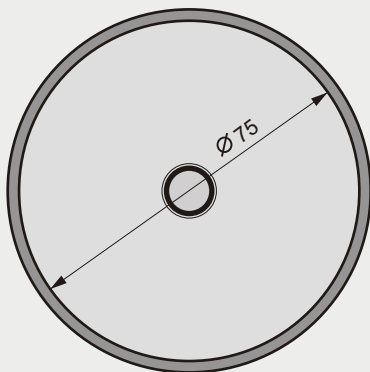
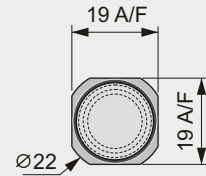
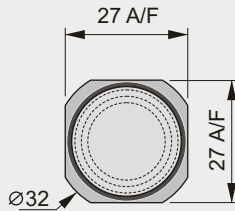
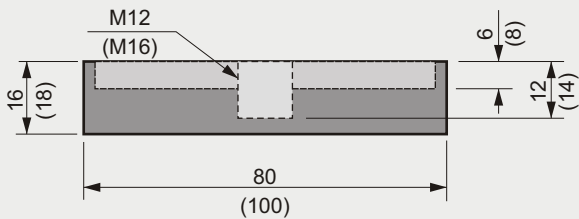

5 T  
Stainless Steel  
Load Adaptor

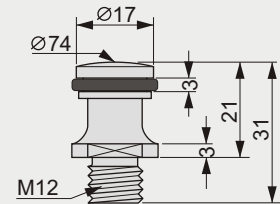

300 kg... 2 T  
Stainless Steel  
Load Adaptor

All Dimensions in mm  
Specifications are subject to change without prior notice

DSSF-3510T-2, 05/09